

SALVATORI

DAL 1946

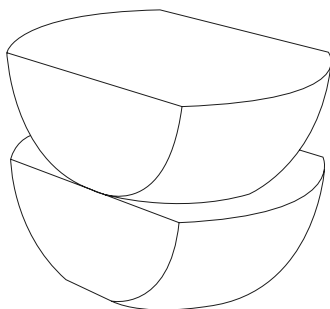

IKONA
SGABELLO / *STOOL*

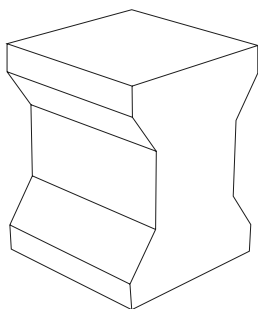
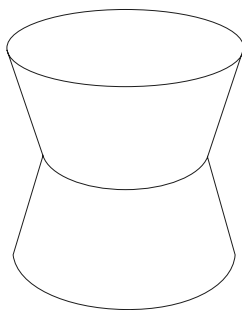
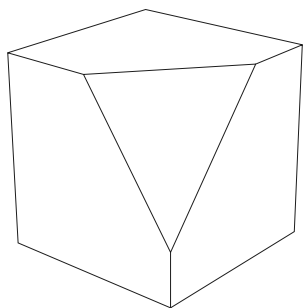

SALVATORI

DAL 1946

Dimensioni / Dimensions

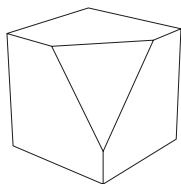

CIPOLLINO
40 x 40 x 45 cm
15.7 x 15.7 x 17.7 in

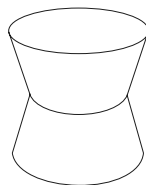

GIALLO EGIZIANO
40 x 40 x 45 cm
15.7 x 15.7 x 17.7 in

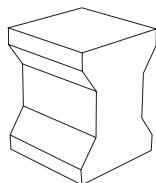

ROSA PERLINO
35 x 35 x 45 cm
13.7 x 13.7 x 17.7 in

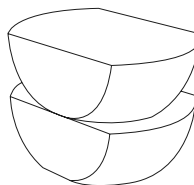

VERDE GUATEMALA
53.7 x 35 x 45 cm
21.1 x 13.7 x 17.7 in

Nell'imballaggio / In the box

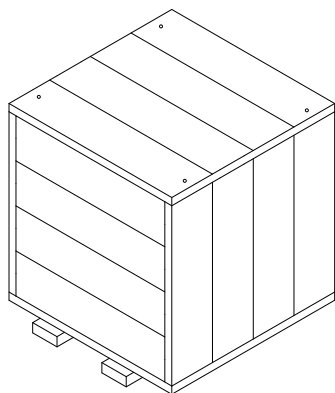

A x1

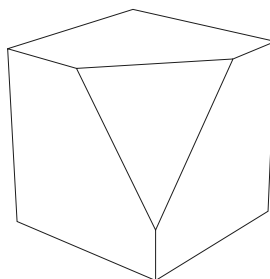

B x1

SALVATORI

DAL 1946

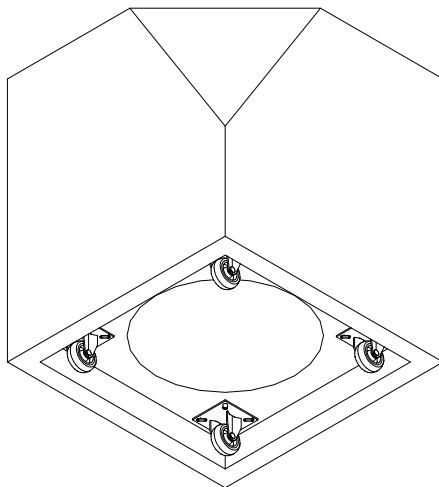

Nota! / Note!

Gli sgabelli ikona sono dotati di ruote per facilitare la movimentazione.
For ease of movement, each piece comes with wheels.

Trattamento superficiale degli elementi in pietra naturale /

Cleaning and maintenance

I nostri sgabelli escono dalla fabbrica già trattati. Poiché non amiamo verniciare con resine o pitture la superficie dei nostri marmi, applichiamo tre strati di sigillante penetrante ad altissimo potere protettivo. In questo modo riusciamo a preservare il prodotto e l'aspetto naturale della pietra.

È necessario ricordare che non esiste un sigillante in commercio in grado di proteggere al 100% la pietra naturale dalle macchie, in particolare se la sostanza penetrante viene lasciata a lungo a contatto con il marmo.

Il sigillante protegge la pietra per qualche minuto dall'attacco dell'agente macchiante (caffè, profumo, ecc.), per cui è necessario rimuoverlo entro pochi minuti per evitare che la macchia si fissi.

Every Ikona stool leaves our factory in Tuscany pre-sealed. Since we do not like to paint the surface of our lovely stone with transparent paints or resins, we apply three coats of the highest possible level of protective penetrating sealant.

This creates a temporary barrier that slows down the absorption into the stone of any staining agents such as coffee, wine, and so on.

That said, please bear in mind that there is no sealer on the market that can make natural stone 100% stain-proof, so we recommend that any potential staining agent is wiped up as soon as possible.

Pulizia quotidiana della pietra naturale / *Everyday cleaning*

Per la pulizia ordinaria delle superfici in pietra, utilizzare sempre saponi o detersivi neutri. Come detersivo neutro Salvatori consiglia FilaBrio. Fare sempre riferimento alle indicazioni riportate sulla confezione del prodotto.

To clean, simply use soap or a neutral detergent such as FilaBrio, always following the instructions provided by the manufacturer.



Nota! / Note!

In nessun caso utilizzare prodotti aggressivi che possano intaccare irrimediabilmente la superficie della pietra, come: alcool, acidi o prodotti anticalcare.

Never use aggressive cleaning products such as acids or limescale removers as these could damage the natural stone.

SALVATORI

DAL 1946

Manutenzione straordinaria della pietra naturale /

Extraordinary Maintenance

Per la manutenzione straordinaria delle pietre Salvatori consiglia:
PS87 PRO: adatto per ogni pietra, per la pulizia di macchie ostinate e per la manutenzione straordinaria.

FOB XTREME: protettivo neutro a base solvente che protegge senza alterare il colore naturale delle pietre.

STONEPLUS: protettivo rattivante a base solvente consigliato per Pietra d'Avola.

*Where particularly assiduous cleaning or maintenance is required,
Salvatori recommends the following products for use on the stone basin:*

PS87 PRO: for the removal of stubborn stains

FOB XTREME: neutral solvent-based protectant which does not alter the stone's natural colour

STONEPLUS: colour-enhancing, solvent-based protectant recommended for Pietra d'Avola.



Nota! / Note!

Fare sempre riferimento alle indicazioni riportate sulla confezione di ogni prodotto.

Always follow the instructions on the package of any product used.

Dati Tecnici / Technical Data

Materiale

Pietra naturale: Cipollino, Giallo Egiziano, Rosa Perlino, Verde Guatemala

Materials

Natural stone: Cipollino, Giallo Egiziano, Rosa Perlino, Verde Guatemala

Texture

Levigato

Textures

Honed

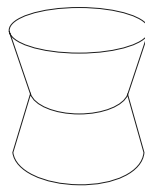
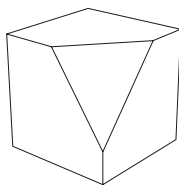

Dimensioni e Pesì Prodotto

40 x 40 x 45 cm; 95 kg

40 x 40 x 45 cm; 55 kg

Product Dimensions and Weight

15.7 x 15.7 x 17.7 in; 209.4 lb

15.7 x 15.7 x 17.7 in; 121.2 lb

Dimensioni e Pesì Imballo

50 x 50 x 65 cm; 145 kg

50 x 50 x 65 cm; 105 kg

Packaged Dimensions and Weight

19.7 x 19.7 x 25.6 in; 319.6 lb

19.7 x 19.7 x 25.6 in; 231.5 lb

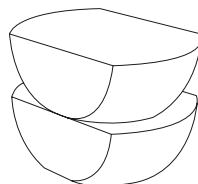
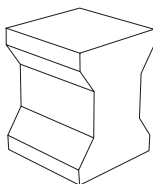

Dimensioni e Pesì Prodotto

35 x 35 x 45 cm; 61 kg

53.7 x 35 x 45 cm; 70 kg

Product Dimensions and Weight

13.7 x 13.7 x 17.7 in; 134.5 lb

21.1 x 13.7 x 17.7 in; 154.3 lb

Dimensioni e Pesì Imballo

45 x 45 x 65 cm; 111 kg

64 x 45 x 47 cm; 120 kg

Packaged Dimensions and Weight

17.7 x 17.7 x 25.6 in; 244.7 lb

25.2 x 17.7 x 18.5 in; 264.5 lb



Nota! / *Note!*

Le misure indicate sono soggette alle tolleranze CE.
Measurements may be subject to slight variances in accordance with CE tolerance standards.

Pietre / *Stones*



Cipollino



Giallo Egiziano

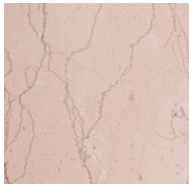

Rosa Perlino

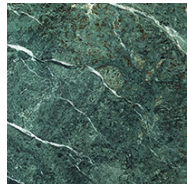

Verde Guatemala

Texture / *Texture*

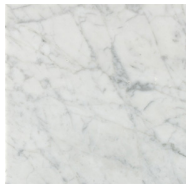

Levigato
Honed

SALVATORI

DAL 1946

Head Office

via Aurelia 395/E
55047 Querceta (LU)
ITALY
T: +39 0584 769 200
info@salvatori.it

Showrooms

Via Solferino 11
20121 Milan (MI)
ITALY
T: +39 02 8050 0372
milano@salvatori.it

26 Wigmore St
London W1U 2RL
UNITED KINGDOM
T: +44 (0)20 748 684 91
info@salvatoriuk.com

 
salvatori_official
info@salvatori.it